

ULTICLEAN 500L



Dental Scaler + Air Polisher

POWER



PERFORMANCE



PRECISION





**ULTICLEAN
500L**

Modern approach for prevention,
cleaning and minimally invasive
prophylaxis treatments.



AIR POLISHING

+ PERIODONTAL TREATMENT

+ ENDODONTIC TREATMENT

+ IMPLANT MAINTENANCE

+ EFFICIENT AND COMFORTABLE PLAQUE REMOVAL

Precise Technology

Delivering your Preferred Oral Health Protocol





ULTRACLEAN
500L

Automatic

identification of procedure mode

Automatically recognises which feature you require when you pick up the either handpiece.

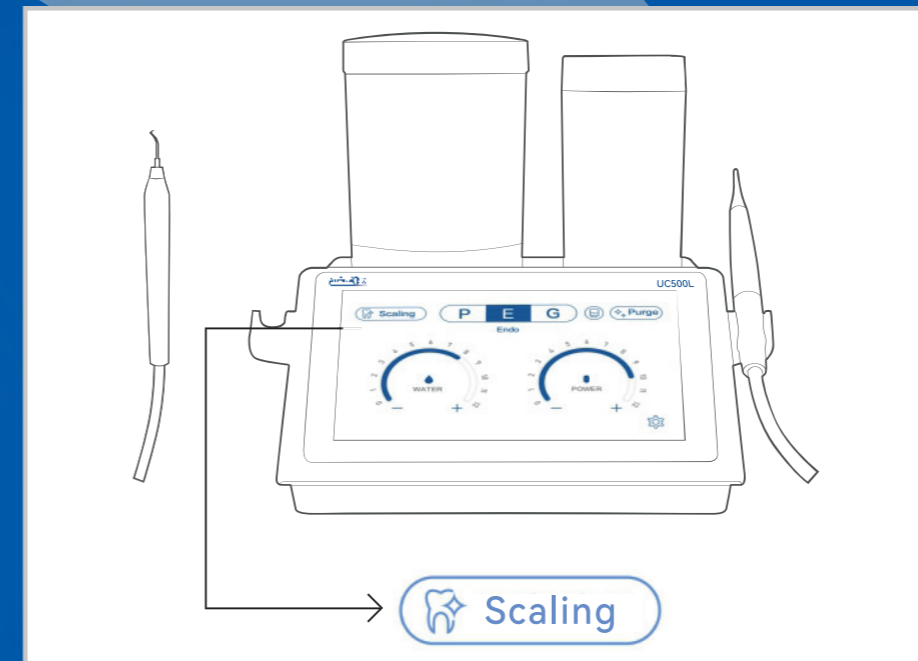

Example of scaling.



Before



After





ULTRACLEAN 500L

Elliptical vibration

The elliptical vibration trajectory can achieve 0° angle operation between the tip and the tooth surface, enabling the polishing effect. This disperses the impact force between the tip and the teeth to achieve more comfortable scaling.

simple + sophisticated handling

Achieve **360°** precision scaling

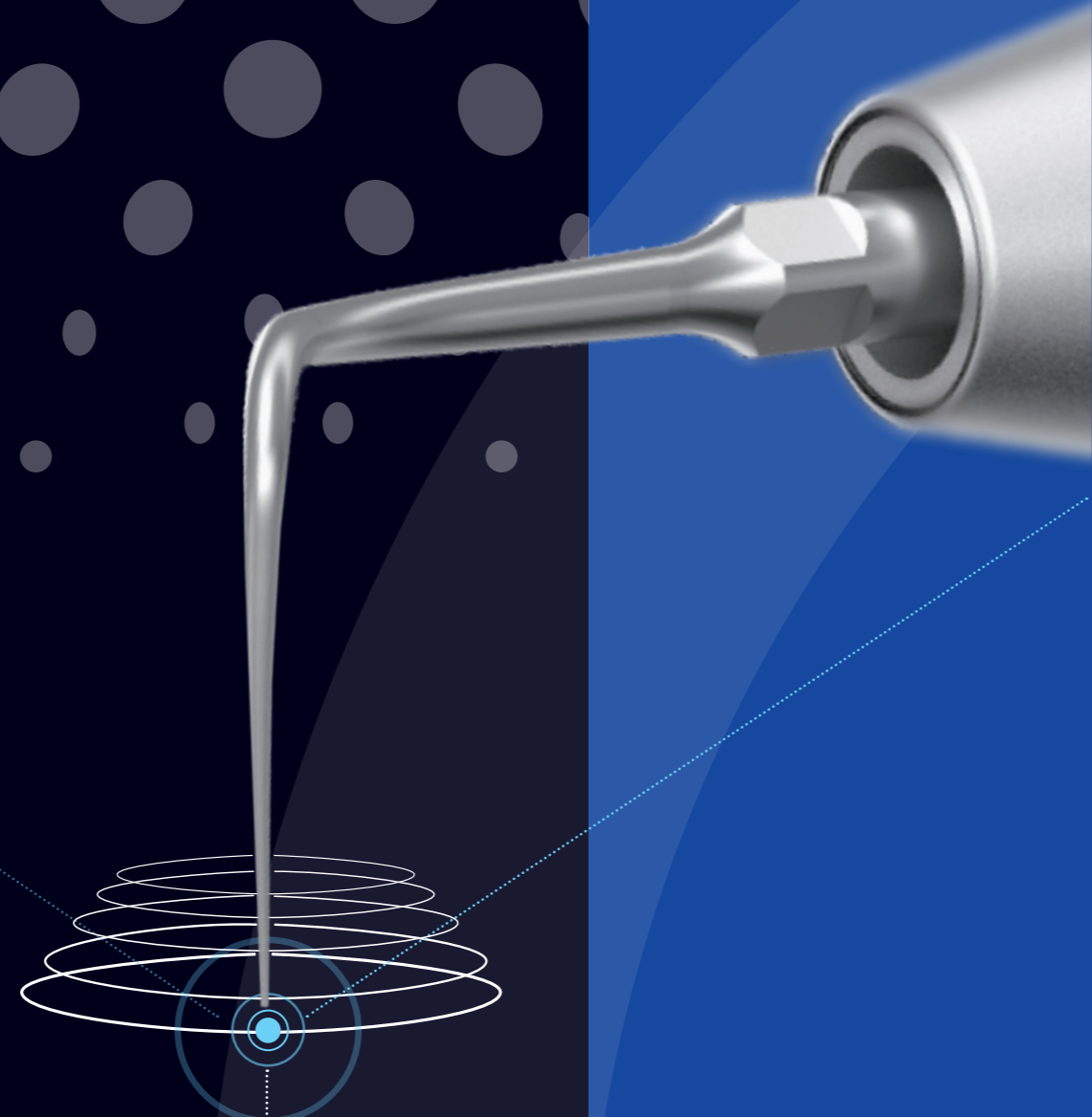

Titanium alloy tip



VIEW			ITEM CODE	SIZE	PROCEDURE TYPE	DESCRIPTION
			BA150180	BAC33E	Periodontal	Remove calculus deep in the periodontal pocket and rinse the periodontal pocket.
			BA150181	BAC50RE	Periodontal	For subgingival calculus detection and subgingival scaling.
			BA150182	BAC50LE	Periodontal	For subgingival calculus detection and subgingival scaling.
			BA150184	BAC59E	Periodontal	For subgingival calculus detection and subgingival scaling.
			BA150183	BAC52E	Scaling	For supragingival scaling and removal of dental calculus / plaque.
			BA150185	BAC56E	Scaling	For supragingival removal of larger calculus.
			BA150195	BAC60E	Endodontic	For preparation and irrigation of root canal.
			BA150196	BAC62E	Endodontic	For Root canal irrigation.
			BA150188	BAC90E	Implant	For cleaning implant and restoration.
			BA150186	BAC94E	Implant	For cleaning implant and restoration.
			BA150187	BAC95E	Implant	For cleaning implant and restoration.

Ultrasonic periodontal treatment

Supragingival and subgingival ultrasonic scaling treatment with elliptical vibration track disperses the impact force between the tip and teeth.

The hardness of titanium alloy tip is lower than that of cementum and enamel, so teeth are not damaged.



Air - polishing

Air polishing is the process of using compressed air to precisely deliver powder and water on the tooth surface to remove tooth surface adhesive substances (such as dental plaque, pigment, biofilm, etc.) and polish the tooth surface.

The Ulticlean powder range includes a perio powder that allows for subgingival cleaning which helps to protect the soft tissue surface.

Efficient and comfortable treatment makes it a more pleasant experience for patients.

Air polishing is less harsh on the tooth enamel with minimal abrasion when compared to conventional scaling and polishing techniques.

Thorough removal of plaque

Air polishing can achieve a significant effect in the the occlusal surface, adjacent surface, orthodontic brackets and other difficult-to clean areas.

Reduce plaque and pigment adhesion

After ultrasonic scaling or manual scaling, patients could feel that the teeth surface is rough and uneven.

The main function of air polishing is to polish and clean teeth surface.

After polishing, the tooth surface is smoother and cleaner therefore making plaque and pigment less likely to adhere to the teeth.



ULTICLEAN
500L



Control

Subgingival air-polishing

Effective at controlling inflamed situations of natural tooth / soft tissue / peri-implantitis effectively and reduce the probing depth.

Compared with traditional scaling air-polishing can clean the tooth surface better as well as the complex thread structure and surface of implants..



UL TICLEAN
500L



Plaque Control

Small-caliber nozzle gives more concentrated air polishing and more efficient plaque removal.

High concentricity of water and air path achieves a good coating of powder by water and reduces the spraying of powder.

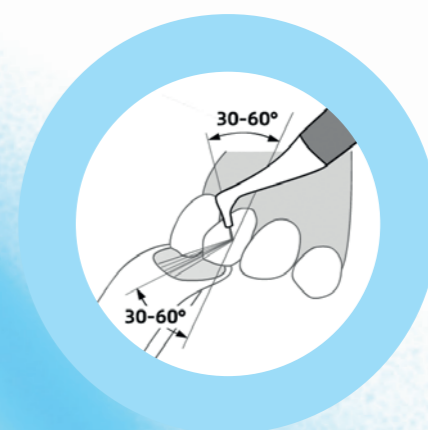

Recommended angle 30° - 60°

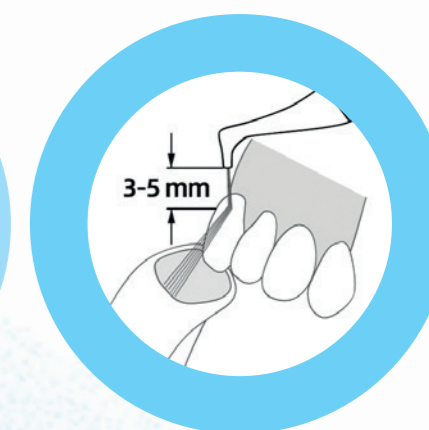

Recommended working distance 3 - 5mm

OUTER: WATER

Washing, Gathering, and adjusting

OUTER: WATER

Provides protection and warm water

INNER

Compressed air & powder

Removes pigments, plaque, biofilm and early tartar



Specially designed Complete Cart system for Ulticlean UC500L
Unit allowing greater hygiene and efficiency.

Compact and unique design

Elegant and efficient cable management system allows you to have an ultrahygienic & functional working station.

Seamless movement - 360

With our high quality wheel system, our cart is designed to give you the best maneuverability around your working space.

Ergonomical

Effective space management with it's frontal storage slots allows you easy access to your Ulticlean powders and dispenser.

From front:
826.5 cm height x 330 cm width
at bottom x 220 cm width at top

From side:
826.5 cm height x 361 cm width
at bottom x 286 cm width at top

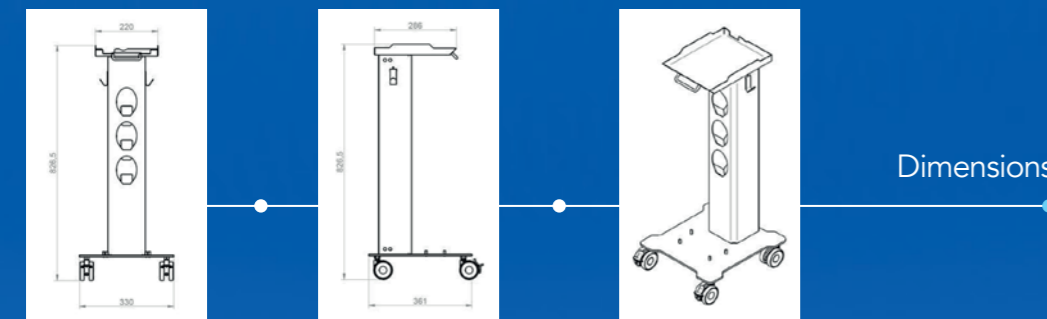

Simple + sophisticated



Multi function foot pedal

- Water-Free power mode
- Boost power mode
- Washing power mode
- Standard power mode

Dual Water Supply

Equipped with two water supply bottles (600ml, 1400ml) made of anti corrosive materials, they can contain special chemicals such as chlorhexidine, hydrogen peroxide, and sodium hypochlorite. External water supply is also available. Water heating unit makes the treatment more endurable.

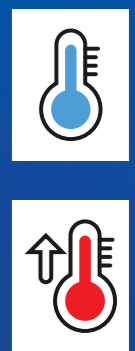



o

n

e

FROM PERFORMANCE TO PEACE OF MIND...

package

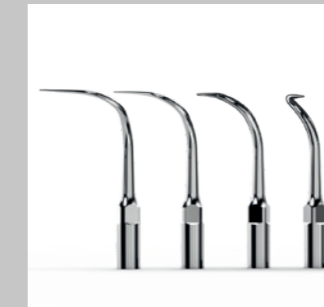

UL TICLEAN
500L

Everything you need to have clinical confidence in **one package**:

The B.A. International repair facility is one of the largest in Europe.

We have integrated the latest ultrasonic and air polishing technologies into a single unit, we can efficiently eliminate biofilm, thereby decreasing the necessity for manual and mechanical instrumentation.

- UC500L unit
- 4 handpieces
- 14 tips included in package
- 2 boxes of Ulticlean Powder
- Smart sleek and ergonomic cart
- Professional installation service
- 3 year warranty
- 12 month service
- This package also includes: torque wrench, sterilisation boxes, cleaning needle, compressor connectors and replacement parts.



BA Ulticlean Prophylaxis

Powder series

Ulticlean Prophylaxis Powder STANDARD
(pack of 4). For supragingival use.

Ulticlean Prophylaxis Powder Perio PLUS
(pack of 4). For sub- and supragingival use.



		STANDARD	STANDARD	PERIO PLUS
ITEM CODE		9796714	9796715	9796716
FLAVOUR		LEMON	MINT	NEUTRAL
RAW MATERIAL BASE		SODIUM BICARBONATE	SODIUM BICARBONATE	TAGATOSE
PARTICLE SIZE Ø		40 µM	40 µM	15 µM
pH		AT 20 °C: 8,1-8,4	AT 20 °C: 8,1-8,4	(10 G/L) AT 20 °C: 6-8
TOOTH	STAINS AND YOUNG TOOTH ENAMEL	✓	✓	✓
	WHITE SPOTS ON THE ENAMEL	✓	✓	✓
	DENTINE	✓	✓	✓
	GUM	✓	✓	✓
GUM	TONGUE AND PALATE	✓	✓	✓
	RESTORATION	✓	✓	✓
RESTORATION	HYBRID COMPOSITE	✓	✓	✓
	GLASS IONOMER	✓	✓	✓
IMPLANT	IMPLANT AND MUCOSITIS	✓	✓	✓
ORTHODONTICS	BRACKETS AND APPLIANCES	✓	✓	✓
		✓	✓	✓
		✓	✓	✓
		✓	✓	✓

Three section air-polishing handpiece

Handpiece design is lightweight and offers less blockages therefore contributing to a longer service life.

Easier cleaning



MATERIAL	GLYCINE	DENTIN	ERYTHRITOL	SODIUM BICARBONATE	ENAMEL
MOHS*	2	2 - 2.5	2.5	2.5	4.5

Standard Configuration

ULTRASONIC HANDPIECE BAC5L	x2	STERILISING BOX	x2	POWDER TANK	x1
AIR-POLISHING HANDPIECE (BAC5P x 1) (BAC5B x 1)	x2	WATER BOTTLE	x2	WATER PIPE / AIR PIPE	x2
TORQUE WRENCH	x2	MULTI-FUNCTIONAL FOOT PEDAL	x1	NEEDLE	x2

Ultrasonic tips selection includes:

BAC33E / BAC50RE / BAC50LE / BAC59E / BAC56E / BAC60E / BAC62E	x2
BAC94E / BAC95E	x1

ITEM CODE	
BA150100	Complete Ultimate UC500L dental scaler and prophy unit
BA150150	BAC5P Air Polisher Handpiece for supragingival treatment
BA150155	BAC5B Air Polisher Handpiece for subgingival treatment
BA150160	BAC5L Ultrasonic Handpiece
BA150160	Single use Nozzles (pack of 10) (Subgingival Air Polisher Tips)

*Mineral of Hardness Scale - a measure of the relative resistance to scratching, measured by scratching the mineral against another substance of known hardness on the Mohs Hardness Scale.

Accessories

Main unit + air-powder sterilizing box and ultrasonic sterilizing box

Air-powder sterilizing box

for sterilization and storage of air polishing handpiece and cleaning needle

Ultrasonic sterilizing box

For sterilization and storage of ultrasonic hand piece and cleaning needle

Outer box

For storage of all UC500L accessories



POWER

PERFORMANCE

PRECISION



ULTICLEAN 500L

B.A.INTERNATIONAL

B.A. International: Unit 7-10, Kingsthorpe Business Centre, Studland Road, Kingsthorpe, Northampton NN2 6NE, England.

+44 (0)1604 777 700 | sales@bainternational.com | www.bainternational.com